

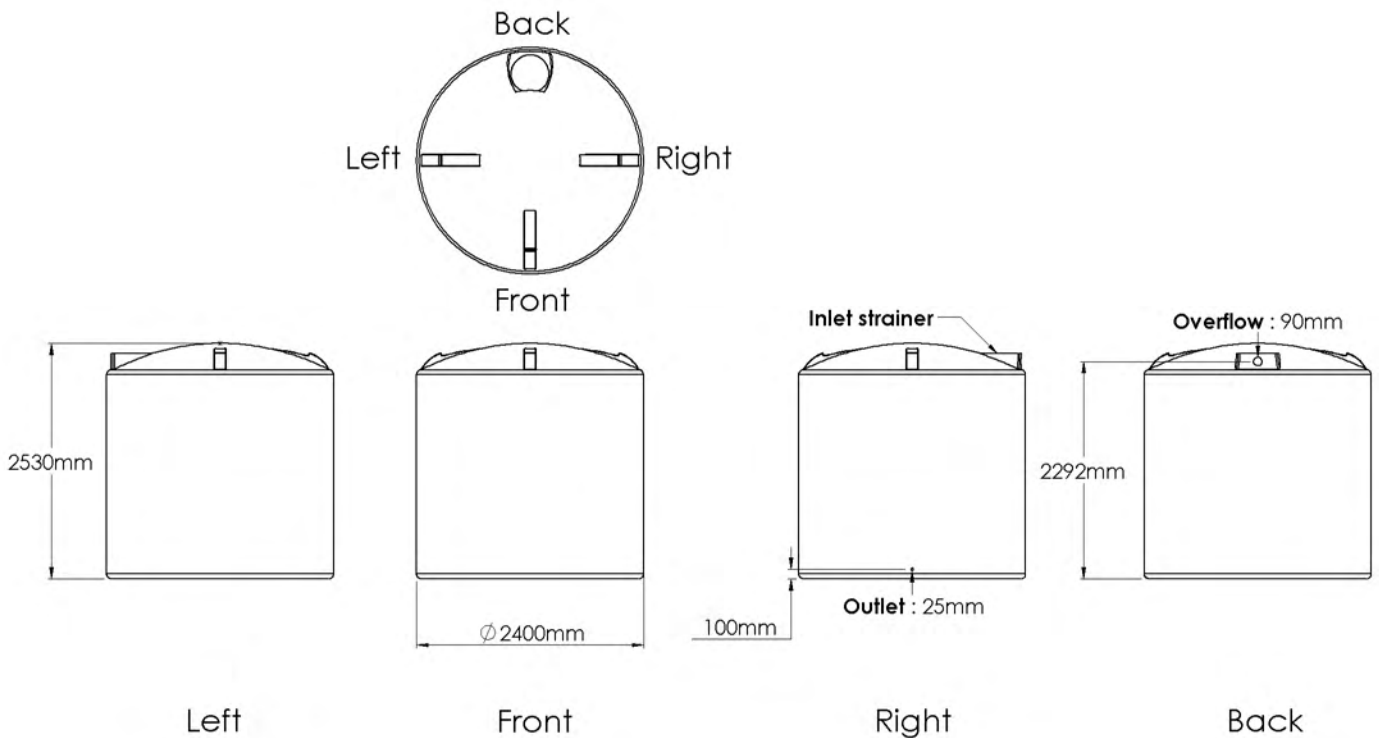

# 10100 L WATER TANK



## Standard Fitout



Supplied: Ball valve, overflow strainer

## Custom Fitout?

Please visit the Tank Range page at: [melro.com.au](http://melro.com.au)  
Click on the *Custom Tank* link below your tank  
Print and complete the form for your tank supplier