

### MELRO CUSTOM TANK FITOUT ORDER FORM

Name:	Tank size: 3000L
Company:	Application:
Contact:	Material:
	Colour:

Please mark up the image below.

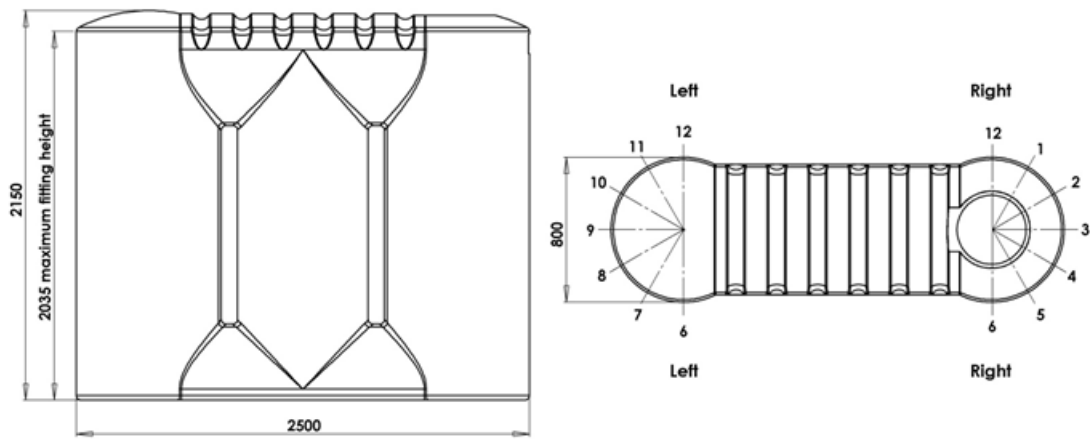

	Fittings required	Position	Height from base
A			
B			
C			
D			
E			
F			
G			
H			

Please send your completed order to:  
Email: melro@melro.com.au  
Fax: 03 8677 1795

If you have any queries, please call us: 03 5940 4334