

2030 TANK CUSTOM FITOUT REQUEST

Name:
Company:
Phone:
Email:
Colour:
This tank will be used for:

Step 1

List required fittings

Code	Fittings Required	O'Clock Position	Height from Base
A			
B			
C			
D			
E			
F			
G			
H			

Step 2

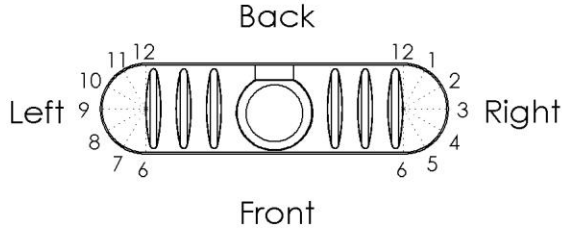

Put code letter at your intended locations below

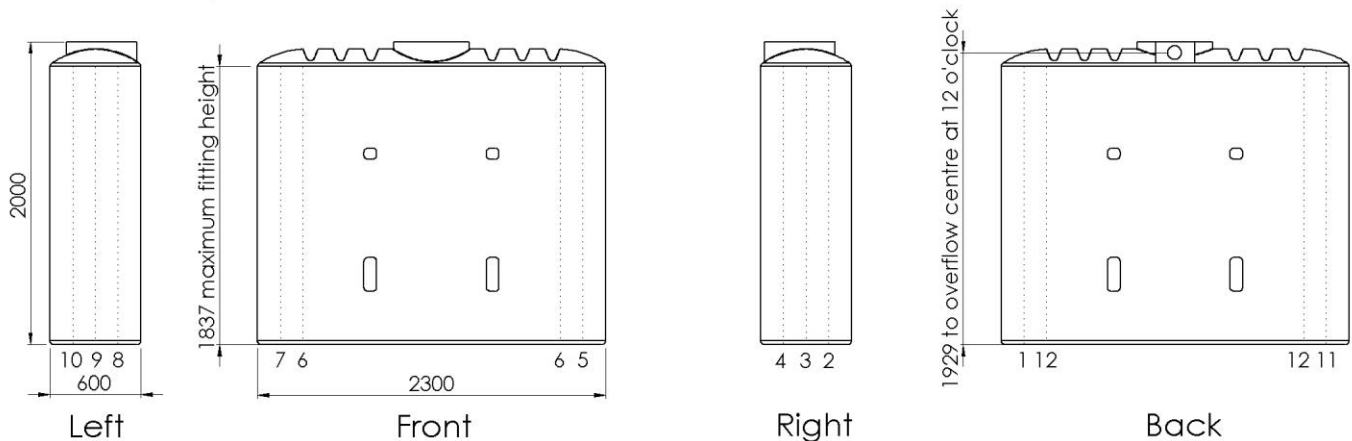

Step 3

Give this sheet to your reseller; or
Email to melro@melro.com.au

Write reseller name & suburb here: